

WARNING: SHUT POWER OFF AT FUSE OR CIRCUIT BREAKER

CAUTION

READ INSTRUCTIONS CAREFULLY FOR SAFE INSTALLATION AND FAN OPERATION. IF UNSURE CONSULT A QUALIFIED ELECTRICIAN

THANK YOU FOR YOUR PURCHASE

Thank you for purchasing this quality product. To ensure correct function and safety, please read and save all instructions before using the product



OWNER'S MANUAL

Read the instructions before installing the ceiling fan. Keep this manual for future reference.

Content: 1 Piece

FEATURES

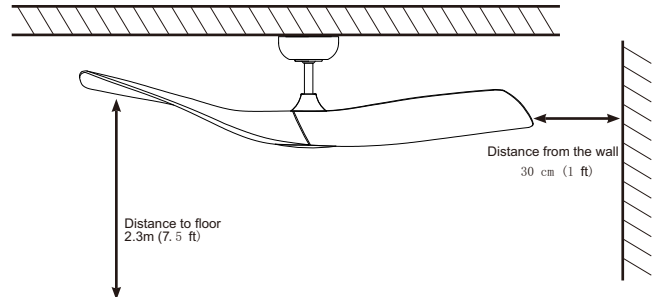

CAUTION!

To reduce the risk of injury to persons the fan must be installed so that the blades are at a height greater than 2.3 meters (7.5 feet) above the floor.

This fan is designed for indoor use.

WARNING / CAUTION

A WARNING / CAUTION notice denotes a hazard. It calls attention to an installation procedure, operating procedure, maintenance procedure, or the like, that if not correctly performed or adhered to, could result in damage to this appliance, personal injury or death. Do not proceed beyond a WARNING / CAUTION notice until the indicated conditions are fully understood and met.

SAFETY SYMBOLS

	Alternating current
	Protective earth
	Warning/ Caution

SAFETY PRECAUTIONS

Please observe the following general safety precautions carefully before and during all phases of handling, installation, removal, operation and maintenance of this product. Failure to comply with these precautions violates safety standards of design, manufacture and intended use of the product. Mercator assumes no liability for customer's failure to comply with these requirements.

SAFETY WARNINGSSAFETY WARNINGS

1. Read all instructions and safety information. Review assembly diagrams provided before installing your new ceiling fan.
2. This fan must be installed by a licensed and qualified electrician according to ETL and local authority regulations.
3. This appliance is not intended for use by persons (including children) with reduced physical, sensory or mental capabilities, or lack of experience and knowledge, unless they have been given supervision or instruction concerning use of the appliance by a person responsible for their safety.
4. Young children should be supervised to ensure that they do not play with the appliance.
5. All electrical works must only be undertaken after disconnection of the power by removing fuses or turning off the circuit breaker, to ensure all pole isolation of the electrical supply.
6. Do not use outdoors where it could be exposed to water or moisture.
7. This manual is not intended to instruct or assist untrained or unqualified persons to install this ceiling fan.
8. It is the responsibility of qualified, licensed installer and user to apply common sense and care at all times during installation and operation.

HOW TO CHOOSE A PROPER LOCATION FOR CEILING FAN

1. According to regulations and to provide a safe clearance from the floor, the lowest point on the fan blade must be at least 2.1 metres (7 feet) from the floor.
2. For fan installed enclosed outdoors, the fan must be installed at least 1.5m from the perimeter of roof/eaves of the enclosure to protect the product from direct or indirect rain water or sunlight.
3. The chosen location for the fan must not allow the rotating blades to come into contact with any object.
4. Please check carefully and make sure that ceiling joists are strong enough and of adequate size to support the weight of about 35 kg.
5. To reduce the risk of fire, electrical shock or personal injury, please make sure that the fan mounting bracket is directly supported from the building structure. Do not mount to an outlet box.
6. The mounting bracket must be firmly screwed to a load bearing building structure e.g. a concrete ceiling, steel structure, or a timber frame. If additional timber frames are to be added, those must be securely nailed or screwed between the beams.
7. Attach fan blades after the fan motor housing is installed and properly secured. Keep the fan motor and blades in the original package until it is ready to be installed.

SAFETY PRECAUTIONS

8. Check and confirm, after the fan is completely installed, that all connections are proper and secure to prevent the fan from falling or causing property damages or personal injury.
9. Take care not to bend or damage the motor Drive Shaft or Fan Blades when handling or installing them. If such defect is noticed, please contact the Customer Service before installation of the ceiling fan.
10. Fan and hanging (mounting) bracket must be earthed.
11. Use of an unapproved remote controller voids the warranty. Only Mercator remote controllers are approved for use with Mercator ceiling fans. Do not use solid state controllers.
12. Do not remove the fan from the ceiling after installation.
13. Make sure electricity is turned off at the main power box before commencing work. Turn off the power by removing fuse or turning off circuit breaker before installing the fan and replacing lamps.

UNPACKING YOUR CEILING FAN

Open the original carton and verify the following items are available for the standard purchase of this product. If there are any missing or mechanically damaged items, contact the Mercator Customer Care. Do not throw away the carton or other packaging material as it may be needed if warranty replacement or repair is ever necessary.

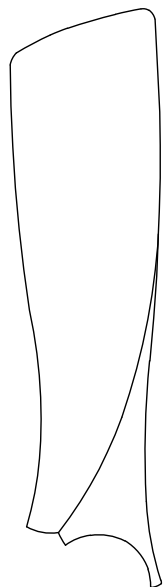

Fan blades (x3)

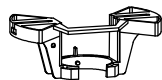

Fan hanger

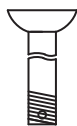

derrick



Joint cover



Decorative covers



Canopy

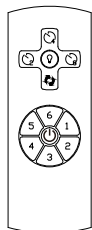

The remote control



The receiver

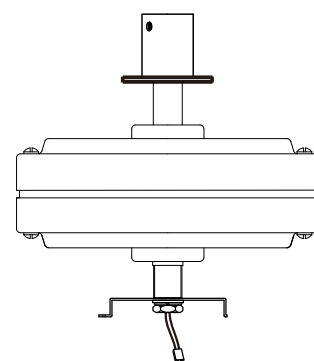

Fan motor assembly

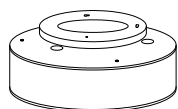

Lamp panel

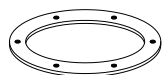

Iron hoop

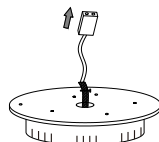

led light kit

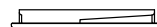

Chimney

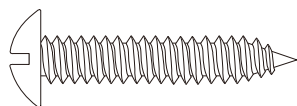

Wood Screw (x4)



Wiring cap(x6)

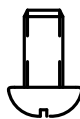

joint screw (x1)



Spring Washer (x4)

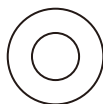

Metal Washer (x4)



star washers(x4)



screws (x2)

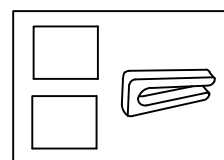

Balance Kit

⚠ CAUTION

- Use of an unapproved remote controller voids the warranty. Therefore do not control the operation of this fan from any remote controller that is not approved by Mercator for use with this fan.
- Do not use solid state controllers.

FAN INSTALLATION INSTRUCTIONS

⚠ WARNING

Make sure electricity is turned off at the main power box before commencing work. Turn off the power by removing fuse or turning off circuit breaker before installing the fan and replacing the lamps.

- The lowest point on the fan blade must be at least 2.1 metres (7 feet) from the floor.
- Make sure that ceiling joists are strong enough and of adequate size to support the weight of the fan of about 35 kg.

Step 1 Install Mounting Bracket

Install the mounting bracket onto the electrical junction box in the ceiling using two machine screws, two washers and two lock washers (*see figure 1*).

The mounting bracket has slotted holes to enable it to move sideways for proper alignment. Make sure the mounting bracket is centered over the electrical junction box and that it is securely attached (*see figure 2*).

NO MOVEMENT SHOULD OCCUR BETWEEN THE MOUNTING BRACKET AND THE ELECTRICAL JUNCTION BOX.

Pull the electrical wires in the junction box down and through the mounting bracket.

Loosen the two canopy mounting screws on the downside face of the mounting bracket. Back them out about half way. This will allow for easier installation of the ceiling canopy later (*see figure 3*).

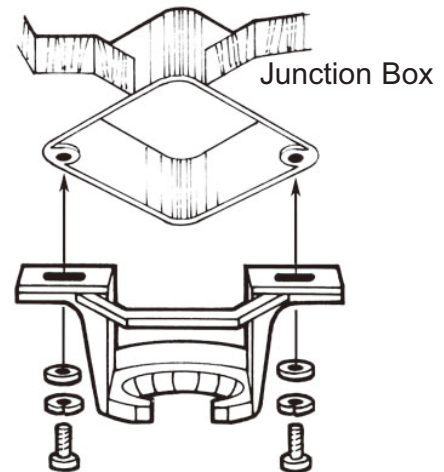

Fig. 1

Slotted Holes

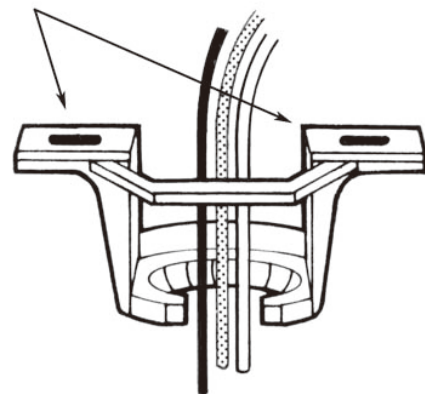
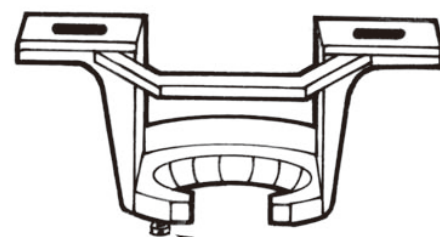

Fig. 2



Ceiling Canopy Mounting Screw

Fig. 3

Step 2 Hanging the Fan Body

Notice the half ball on the end of the support rod is grooved down one side (*see figure 4*). This keyway fits over the small keyway pin on the inside of the mounting bracket and keeps the ceiling fan from spinning on the mounting bracket.

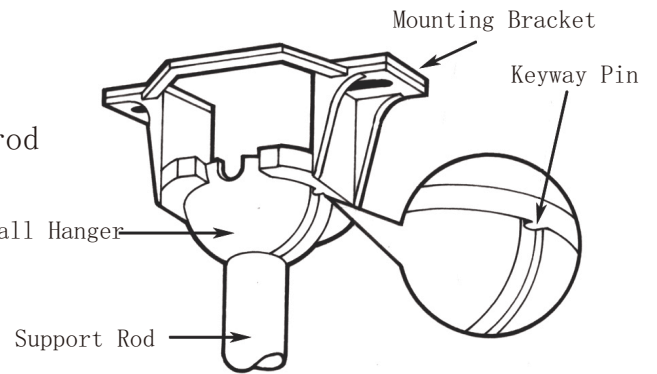

Fig. 4

Using your step ladder, lift the fan and place the half ball in the center of the mounting bracket with the keyway pin inserted into the keyway on the ball. Turn the fan left and right slightly to make sure it is seated on the bracket with the keyway pin in the keyway (*see figure 5*).

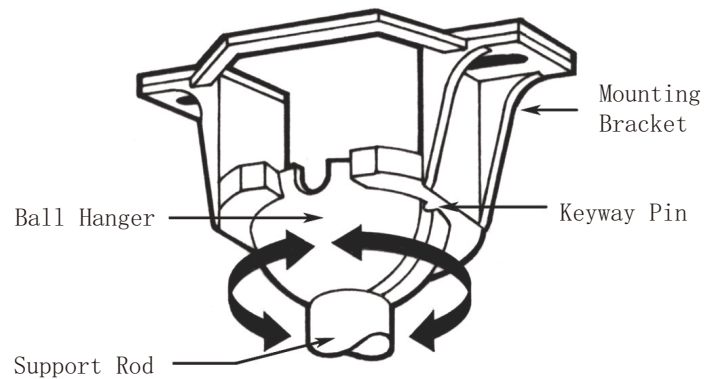

Fig. 5

Trim the lead wires, leaving about six inches each wire extending from the support rod (*see figure 6*).

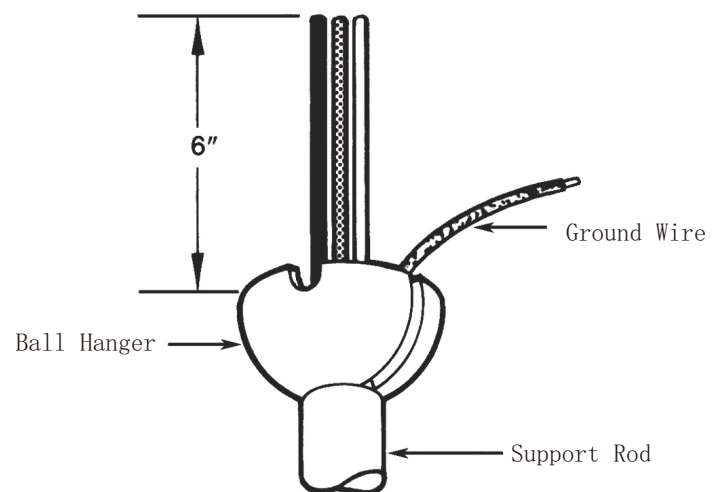

Fig. 6

Step 3 Making the electrical connections

To operate your ceiling fan with the pull chain(s) and switches mounted on your fan, follow the instruction below (see figure 7-1)

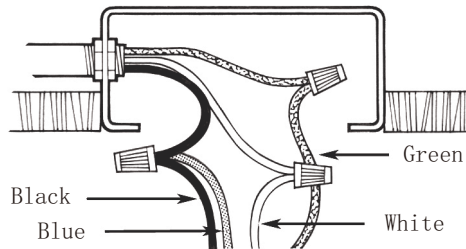
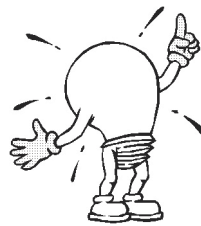

Fig. 7-1

Attach the GREEN wire (connected to the half ball) to the GROUND wire in the junction box. The GROUND wire is usually a bare copper wire without plastic insulation. It could also be covered in green plastic insulation.

Attach the BLACK wire and BLUE wire from the ceiling fan to the BLACK wire in the junction box.

Attach the WHITE wire from the ceiling fan to the WHITE wire in the junction box.



Each of the above connections should be made as tight as possible using the proper size plastic wire nuts. Plastic electrical tape is not recommended for these connections.

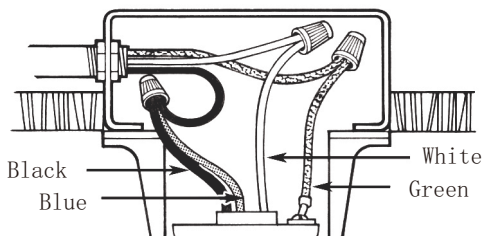
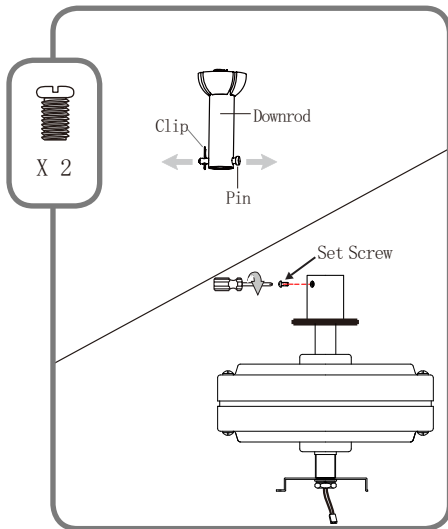

Fig. 7-2

Fold the connected wire (see figure 7-2) and push them up inside the electrical junction box with the BLACK and BLUE wires to one side and the WHITE and GREEN to the other side. Make sure the wire nuts do not come loose during this operation.

Step 4 . Install fan body



1. Loosen set screws and remove the pin and clip from the downrod. Remove the clip and pin from the downrod. Then partially loosen the two set screws in the yoke at the top of the motor assembly.

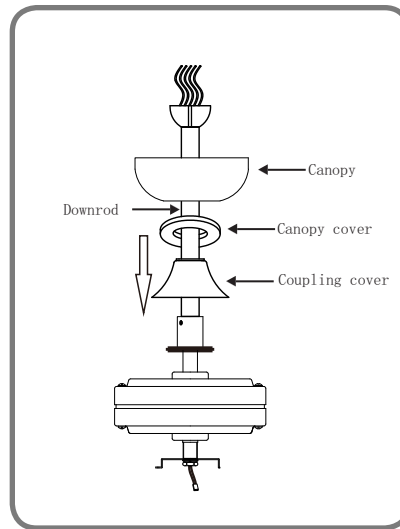

2. Feed the wires through the canopy and downrod. Insert the downrod through the canopy. Then, feed the fan wires through the downrod.

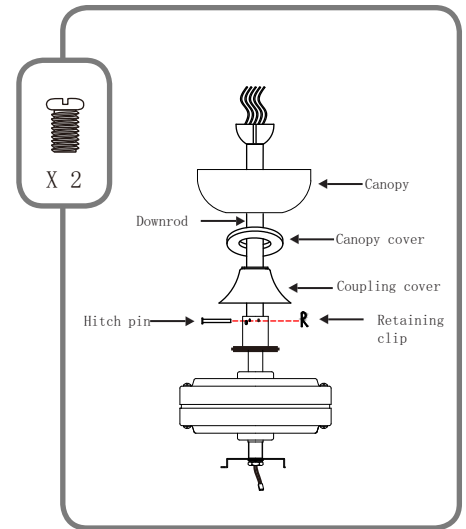

3. Install the downrod into yoke. Slide the downrod into the yoke at the top of the motor assembly. Align the holes, and reinstall the pin and clip. Then tighten both set screws.

Step 5 . Fan blade installation.

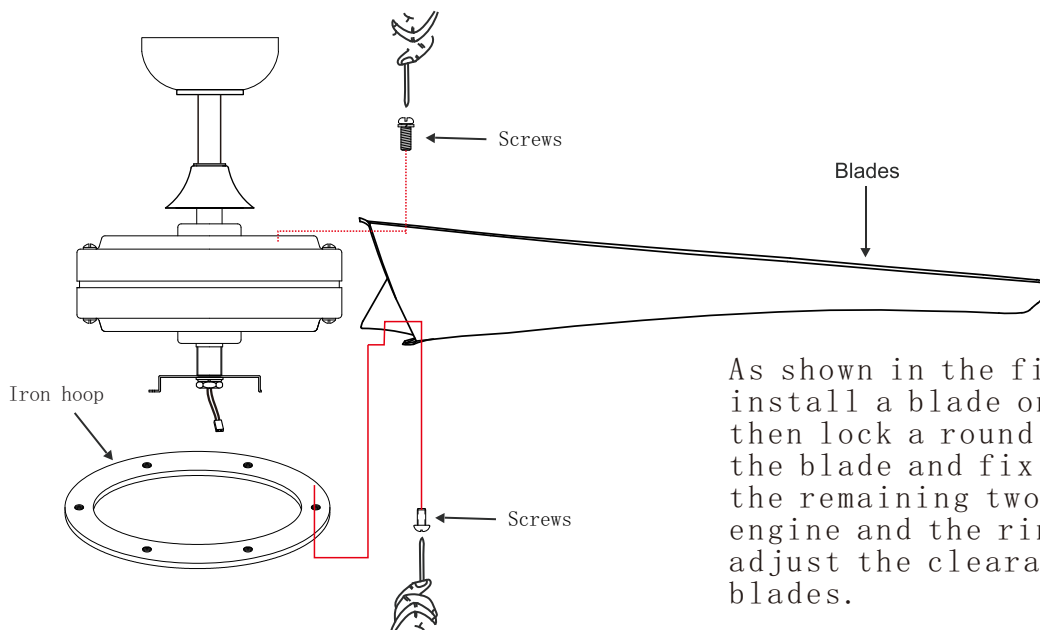

As shown in the figure, first install a blade on the main machine, then lock a round iron ring inside the blade and fix the screws. Fix the remaining two blades on the main engine and the ring in turn, and adjust the clearance between the blades.

Step 6 . Install LED light plate

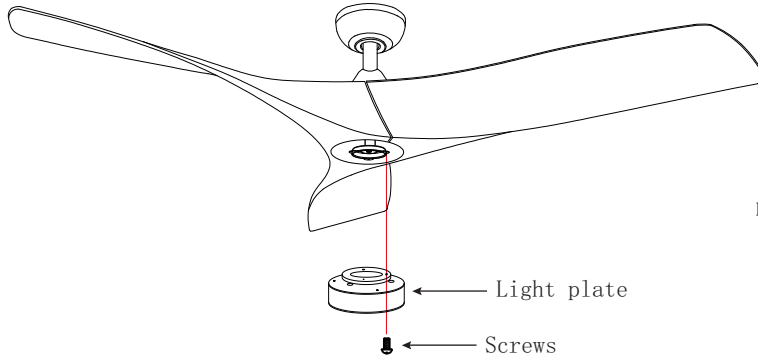

As shown in the picture on the left, install the LED fixed disk on the main machine and pay attention to the lamp line through the middle.

Step 7 . Install LED Light Kit

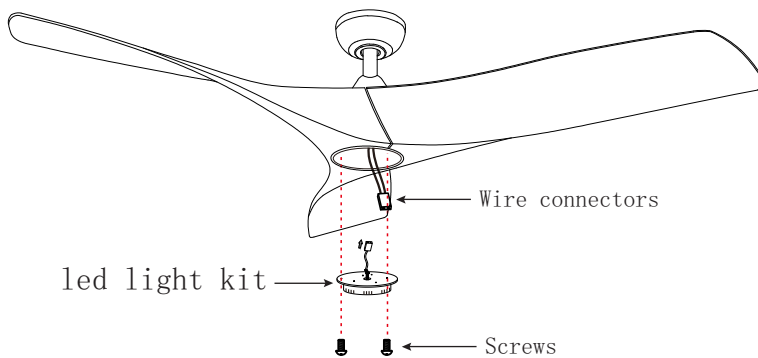

Connect the light source set to the host conductor via the wire connector as shown, and then screw it to the lamp panel.

Step 8 . Install acrylic lampshades

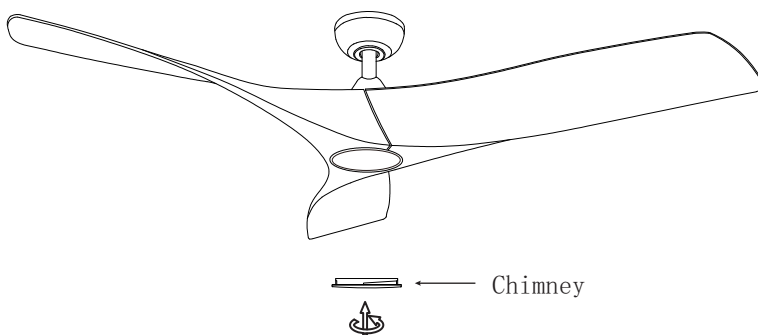



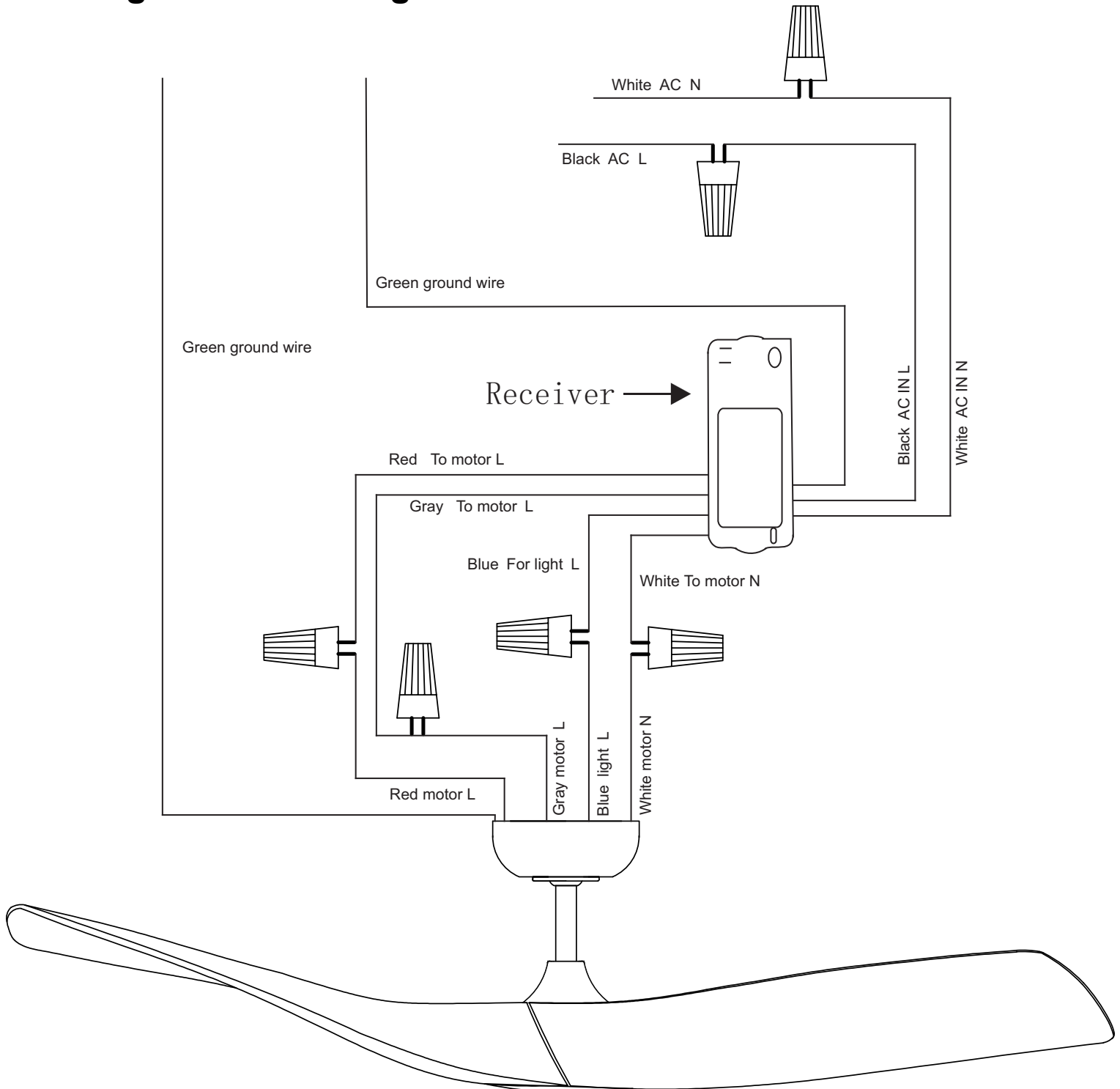

As shown in the figure, put the acrylic lamp shade into the lamp pan and turn it to the right and fix it with gentle force.

Wiring schematic diagram



Button function instruction

1. speed control button of fan: 1 2 3 4 5 6 are speed button.
2.  :ON/OFF the lamp
3.  :Turn off the ceiling fan.
4.  Fan timing button: 2H. 4H and 8H.
5.  : Controls the direction of the fan "Forward and Reverse".
6. Battery for RF emitter: 12V 23A
Battery for emitter:UM-44 AAARo3 DC 1.5Vx2.
7. RF emitter:Remote control distance at 25-30 meters.
emitter:Remote control distance within 10 meters.

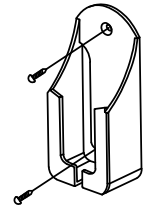
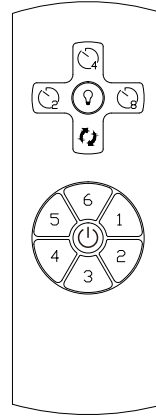

Installation of transmitter wall

Mount holder with two screws.

Wiring diagram:

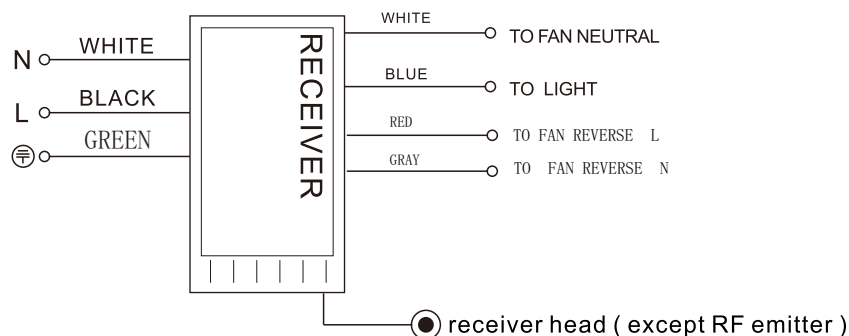

Note:

Please connect relevant components strictly following instructions on the label. Otherwise switch life will be influenced directly and the switch will fail to function.

1. The fan switch must be on status, and our product can control fan.
2. When the emitter can not control the receiver, please check whether battery touch is normal, the placed of anode and cathode is correct and power is enough.
3. Please use product in allowable voltage, it is not normal if the voltage is too low. (Please check the label for voltage range and correlative technique parameter.)
4. When the emitter can not control the receiver, please check if there are similar remote control products existing in the nearby range, and check whether their launcher buttons are pressed, because remote control products with the same properties launching electric wave at the same time, will cause mutual interference and influence the receiving effect; and that will be normal again after the remote control function is eliminated. (Exclude the remote control)
5. Please take out the batteries when not use in a long time.
6. Requirements for each load: bulb \leq 300W; fan \leq 120W.

IMPORTANT FACTS

All electric motors, including fan motors make some noise and may feel hot to touch - this is not a fault. Ceiling fans tend to move during operation as they are not generally rigid-mounted. Rigid mounted ceiling fans generate excessive vibration and stress on their mountings.

Movement of a couple of centimetres is quite normal and does not suggest the fan will fall down.

Please note - all ceiling fans are not the same, even in the same model some may move more or less than others.

Fan lights can rattle, if they are not supplied with the fan. They are not covered by warranty.

FAN OPERATION

A ceiling fan is an environmentally smart choice when it comes to cooling as well as helping to warm your room. You should see a reduction in both cooling and heating costs by regular use of your fans.

Do not hesitate to use your fans in both summer and winter months.

In summer fans should be set to spin in anti clockwise direction blowing down cool breeze.

In winter, fan should be set to spin in clock wise direction so that an upward airflow will push warm air off the ceiling and circulate it downwards into the living areas. In winter months use the fan on a lower speed than in summer.

NORMAL WEAR AND TEAR

Threaded components working slightly loose, or blade carriers becoming slightly bent due to vigorous cleaning or bumping can cause extra wobble and noise. This is not covered under warranty, but a little care and maintenance can reduce or prevent this problem.

NIGHT NOISES

This is the biggest cause of service calls, which are outside the manufacturer's warranty. If a fan has a fault it will be noticeable at all times. Naturally when everything is quiet at night you will be more inclined to hear small noises, which may not be noticeable at other times. Even slight signals super imposed in your electricity supply for off peak hot water control may cause a change in the fan motor noise. This is normal.

Modelo: F6262110V

CARACTERISTICAS ELECTRICAS:

Parrotuncle Lighting, 218 Black Tie Lane, Chapel Hill, NC www.parrotuncle.com

Parrot Uncle YOU CAN BE SURE OF are trademarks of Eileen Grays LLC.

Used under license by Eileen Grays LLC.

All rights reserved.

Made in CHINA