

HOME DECORATORS COLLECTION

BF-20191 HAMPTON BAY 4 DOOR CABINET

INV#26012



ASSEMBLY INSTRUCTIONS

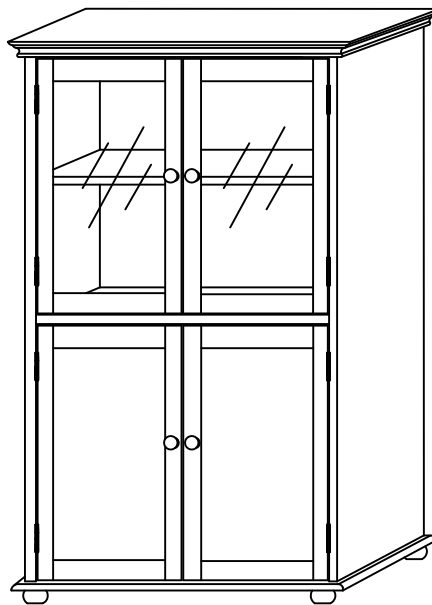





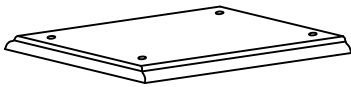

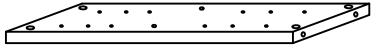
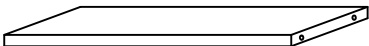
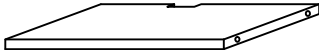
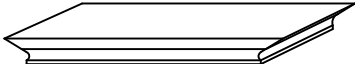
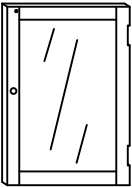
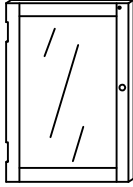
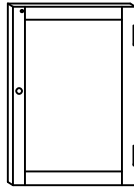
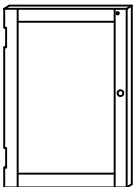
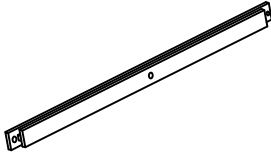
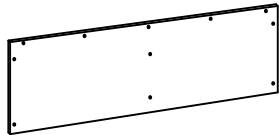

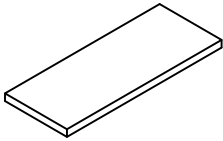
Made In China

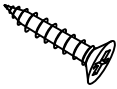
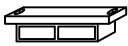

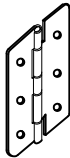
Thank you for purchasing this quality product. Be sure to check all packing material carefully for small parts, which may have come loose inside the carton during shipment. Count all parts and material hardware and then compare with parts list to be sure all parts are present. If any parts are missing or damaged, phone, fax, or mail to our Customer Service Department for efficient and speedy service. Please indicate the model number and code letter of part(s) needed.

IMPORTANT NOTE: Follow instructions listed below in proper sequence as numbered to assure fast, easy and correct assembly.

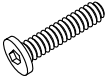
PARTS LIST		
A  BOTTOM PANEL-1PC	B  FEET-4PCS	C  LEFT SIDE PANEL-1PC
D  RIGHT SIDE PANEL-1PC	E  ACROSS PANEL-1PC	F  TOP PANEL-1PC
G  LEFT DOOR-1PC	H  RIGHT DOOR-1PC	I  LEFT DOOR-1PC
J  RIGHT DOOR-1PC	K  REAR PANEL GUIDE-1PC	L  BACK PANELS-2PCS

<p>M</p>  <p>SHELVES-2PCS</p>	<p>N</p>  <p>CAM BOLTS-12PCS</p>	<p>O</p>  <p>CAM LOCKS-12PCS</p>
<p>P</p> <p>6mm × 3/4"</p>  <p>SCREWS-3PCS</p>	<p>Q</p>  <p>LARGE MAGNETS-2PCS</p>	<p>R</p> <p>7mm × 5/8"</p>  <p>SCREWS-28PCS</p>
<p>S</p> <p>5mm × 1/2"</p>  <p>SCREWS-52PCS</p>	<p>T</p>  <p>HINGES-8PCS</p>	<p>U</p>  <p>FEMALE MAGNETS-4PCS</p>
<p>V</p>  <p>KNOBS-4PCS</p>	<p>W</p> <p>8mm × 5/8"</p>  <p>SCREWS-4PCS</p>	<p>X</p>  <p>SHELF SUPPORTS-8PCS</p>
<p>Y</p> <p>11mm × 1-1/4"</p>  <p>SCREWS-4PCS</p>	<p>Z</p>  <p>CAM-TOOL-1PC</p>	<p>A1</p>  <p>ALLEN WRENCH-1PC</p>

NOTE: THE SURFACE WITH THE STICKER IS THE BACK SIDE.

NOTE: • UPON OPENING THOROUGHLY CLEAN ALL WOODS SURFACES TO REMOVE DUST AND DIRT THAT MAY HAVE SETTLED ONTO FINISH DURING SHIPMENT. IN ORDER TO PREVENT DAMAGE DURING ASSEMBLY, PLEASE ASSEMBLE THIS ITEM WITH AT LEAST TWO PEOPLE.

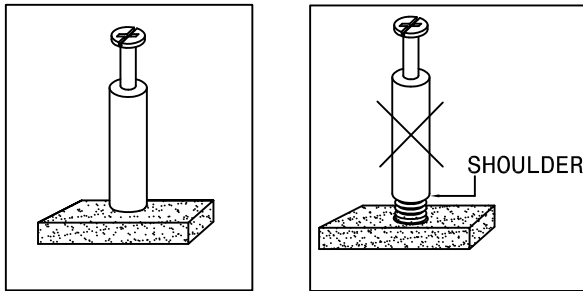

NOTE: TURN THE CAM-BOLT SCREWS UNTIL THEY ARE TIGHT, THE SHOULDER SHOULD BE AGAINST THE SURFACE OF THE PART.

HOW TO USE THE CAM-TOOL

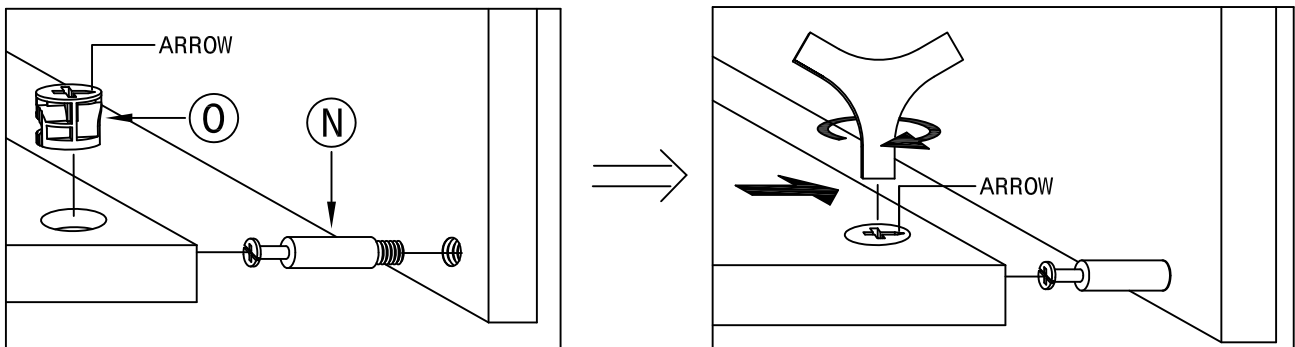

NOTE: • THE ARROWS ON THE HIDDEN CAM-LOCKS SHOULD POINT TO THE CAM-BOLTS

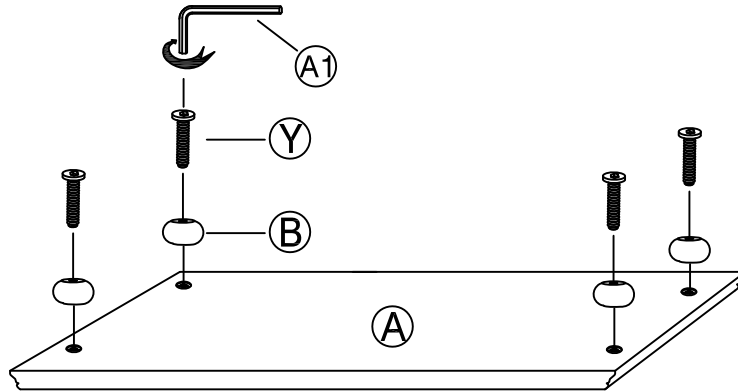

1) . ASSEMBLE THE FEET (B) .

- ATTACH THE FEET (B) TO BOTTOM PANEL (A) USING SCREWS (Y) .

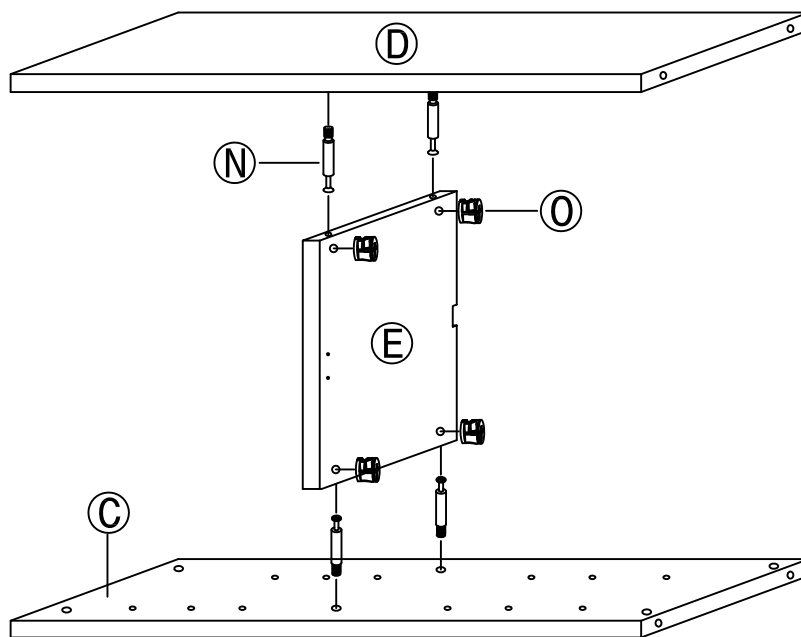

2) . ASSEMBLE THE SIDE PANEL (C/D) .

- ROTATE THE CAM-BOLTS (N) INTO THE HOLES IN THE SIDE PANEL (C/D) .
- PLACE THE CAM-BOLTS (N) INTO THE HOLES IN THE PANEL (E) AND ATTACH USING CAM-LOCKS (O) .

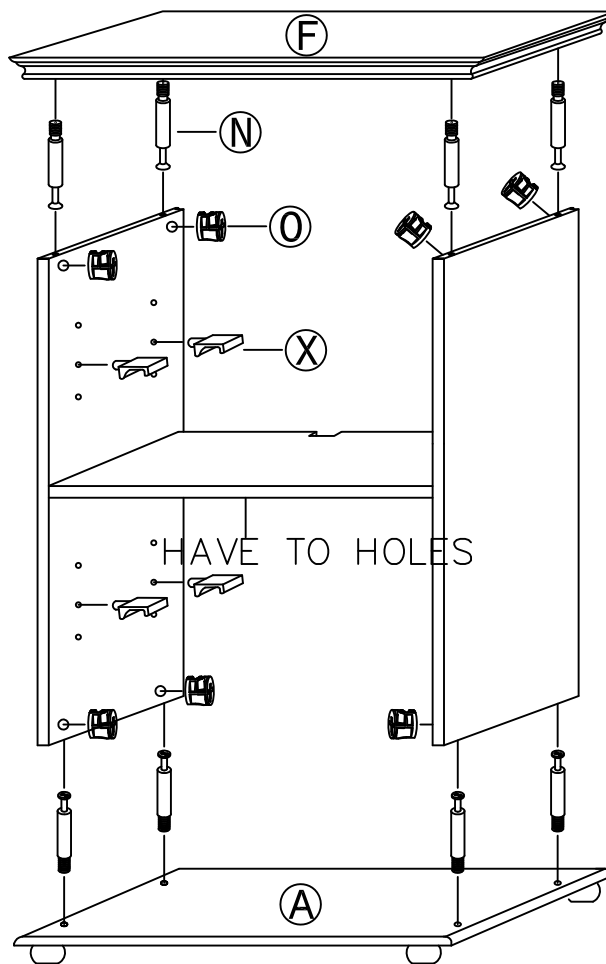

3) . ASSEMBLE THE TOP/BOTTOM PANEL(F/A) .

- ROTATE THE CAM-BOLTS(N) INTO THE HOLES IN THE TOP/BOTTOM PANEL(F/A) .
- PLACE THE CAM-BOLTS(N) INTO THE HOLES IN THE PANEL(C/D) AND ATTACH USING CAM-LOCKS(O) .
- INSERT THE SHELF SUPPORT(X) INTO THE HOLES OF THE SIDE PANEL(C/D) .

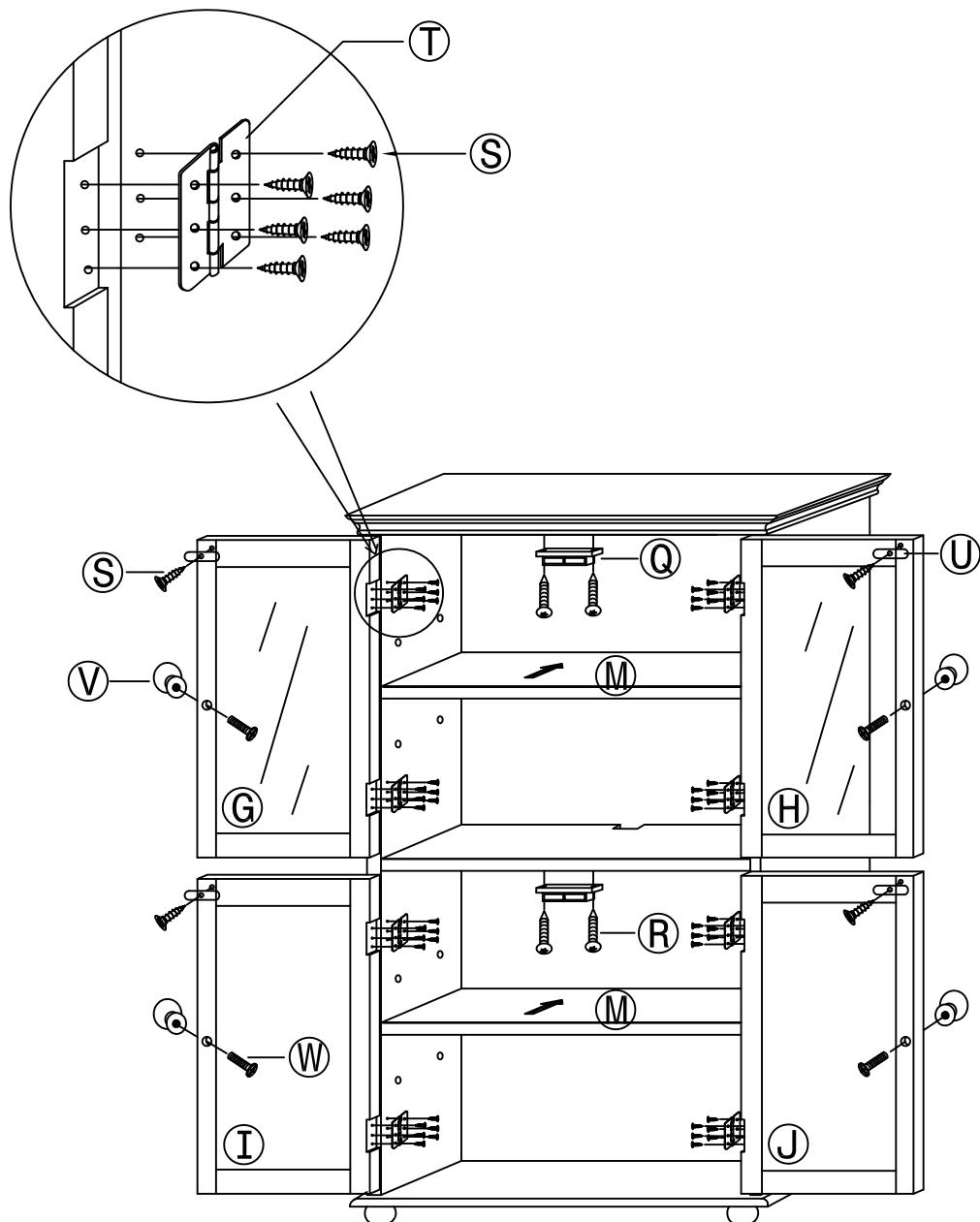

4) . ASSEMBLE THE DOORS(G/H/I/J) AND SHELVES(M) .

- ATTACH THE 8 HIGNES(T) TO DOORS(G/H/I/J) AND SIDE PANEL(C/D) USING SCREWS(S) .
- ATTACH THE FEMALE MAGNETS(U) TO THE DOORS(G/H/I/J) USING SCREW(S) .
- ATTACH THE KNOB(V) TO THE DOORS(G/H/I/J) USING SCREWS(W) .
- ATTACH LARGE MAGNET(Q) TO TOP PANEL(A) AND ACROSS PANEL(E) USING SCREWS(R) .
- FINALLY, PUT SHELVES(M) ONTO SHELF SUPPORT(X) .

Note: Before you assemble the back panel, please make sure the doors have an even gap around them. If uneven, shift the unit LEFT OR RIGHT UNTIL the doors are evenly spaced, then attach back panel.

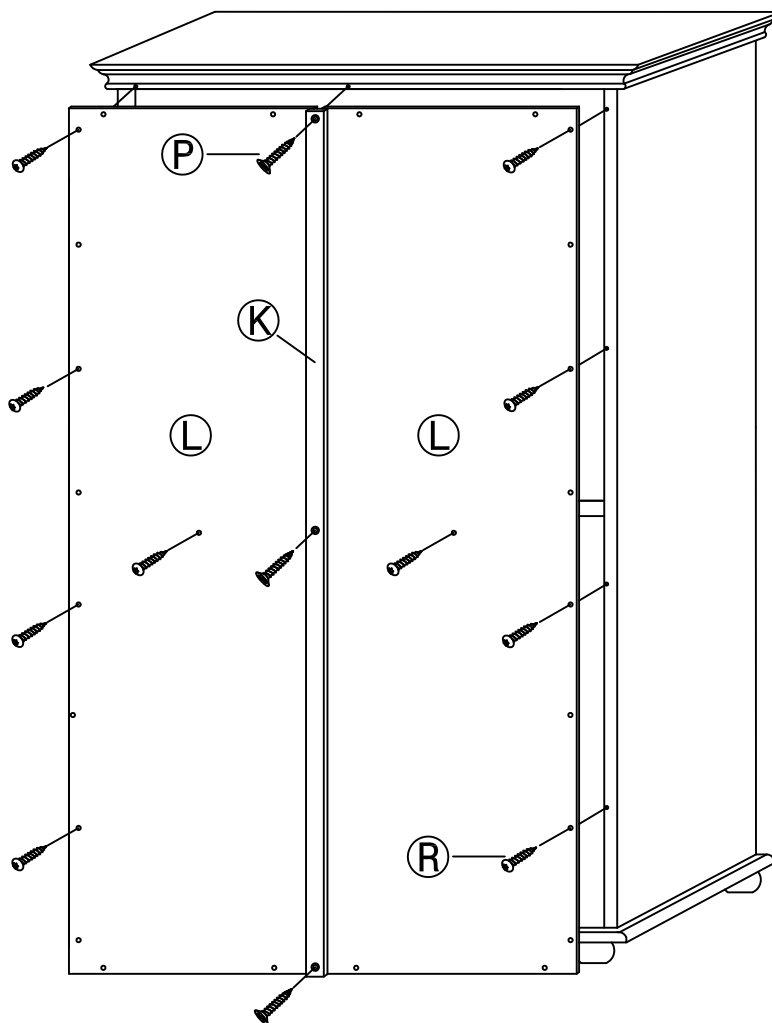

5) . ASSEMBLE THE BACK PANEL(L) .

- INSERT THE BACK PANEL(L) INTO THE SLOT IN THE REAR PANEL GUIDE(K) .
- ATTACH THE BACK PANEL(L) AND REAR PANEL GUIDE(K) USING SCREWS(R/P) .