



marey®

ECO110

ELECTRIC TANKLESS WATER HEATER

**INSTRUCTIONAL
MANUAL**



Keep this manual with you after your unit has been installed, you may need it for further technical information.

☎ USA (855) 627-3955

🌐 www.Marey.com

☎ PR (787) 727-0277



Congratulations! You've just purchased a new Marey ECO110 tankless water heater and will soon begin to enjoy the benefits of "going tankless."

Take the time to thoroughly read and understand this safety and installation manual in its entirety before you attempt to install your new ECO110 tankless water heater, as it contains important safety tips and instructions.

Please carefully read all instructions and warnings. Should you have any questions, please visit www.marey.com for installation videos and FAQ.

Please keep this manual for future reference and technical information.





INDEX

QUICK START GUIDE	04
WARNING	05
IMPORTANT WARNINGS	05
IMPORTANT SAFETY INFORMATIONS	05
PRODUCT FEATURES	06
PRODUCT ADVANTAGES	07
TECHNICAL SPECIFICATION AND INSTALLATION REQUIREMENTS	08
PRODUCT INNER STRUCTURE	09
INSTALLATION GUIDELINE	09
INSTALLATION DIAGRAM	10
OPERATING INSTRUCTIONS	14
TROUBLE-SHOOTING/DIAGNOSTIC CHART	15
NORMAL MAINTENANCE	15



ECO110

1) Mounting

Plot the three holes for the mounting screws onto the wall. Mount vertically on a flat surface (i.e. board or wall) larger than the unit itself. Make sure heater is secure by utilizing a stud or the provided wall anchors. Keep away from any potential splashing or

2) Water Connections

Plumbing connections are ½" NPT, and both the inlet and outlet can be found at the bottom of the unit. When installing your water connections make sure to use ½" NPT fittings. Please use the provided gaskets to prevent leaks. When tightening fittings, use a back-up wrench on inlet and outlet fittings (flat sides of fittings are located behind front cover). The cold water inlet is on the right side it should be preceded by a high pressure discharge valve and a shut off valve in that order. The hot water outlet is on the left side and runs to your hot water source. NEVER USE PVC ON HOT WATER OUTLET. Use instead CPVC or other high temperature rated materials. Run water through the heater for a few minutes to purge all air from the system. Shut off flow at

3) Electrical Connections

Power wires and ground come into the unit from the upper right hand side of the back panel. Use 6 AWG for your ground wire, running from the "E" space in the terminal block all the way to the ground bar of the breaker panel. Run one 6 AWG wire from each of the "L1" and "L2" connection points of the terminal block to the double pull 70 amp breaker at your panel.

4) Operation

After power is supplied a beep can be heard. Turn on hot water faucet unit will activate upon water flow, display should show actual outlet temperature. Push power button if unit does not change due to water flow. Set desired temp with the up and down arrows. Test water to prevent scalds.



WARNING

If your water heater requires a reset, be sure to **TURN OFF THE BREAKER** prior to resetting the unit.

Resetting your unit without turning off the breaker can result in personal injury and damage to your water heater.

WARNING! There is water contained in the coils of your water heater at all times. If your water heater is exposed to freezing temperatures, the water in the coils could freeze, causing a break in the heat exchanger of the unit, or the supply and return lines. This kind of damage will result in water running freely into the space where the water heater is located, which can cause flooding. **DO NOT** install this water heater where it may be subjected to a freeze. If your water heater is in an area where freezing is a possibility, you must turn off the water to the heater and drain it of any water by disconnecting the water lines. Leave the water lines disconnected until you intend to use



IMPORTANT WARNINGS

This is not a do-it-yourself task. Failure to have this appliance installed by a licensed plumber and electrician will void all warranties.

Do not attempt to install, repair or disassemble the tankless electric water heater without first shutting off the power to the unit directly at the circuit breaker box.

Installation of this product is restricted to indoor locations only by licensed plumbing or electrical contractors.



IMPORTANT SAFETY INFORMATIONS

1. The installation must be in compliance with the National Electrical Code, your local electrical and plumbing codes.
2. This appliance must be **EARTH ED**.
3. All wiring and installation must be supervised by a qualified electrician.
4. **CAUTION** :This product has more than one power-supply connection point. Disconnect all power supplies before servicing.
5. This appliance is not designed to be used by people (children included) with reduced physical sensory or mental capabilities, or lack of experience and knowledge, unless

they have been given supervision or instruction concerning use of the appliance by a person responsible for their safety. Children should be supervised to ensure that they do not play with the appliance.

6. This appliance **MUST** be permanently connected to the fixed circuit breaker and it must be installed vertically. **DO NOT** install this appliance near tinder or a strong magnetic field place.

7. This appliance is forbidden to be switched on if you think it might be frozen, as this could result in serious damage to the unit. Wait until you are sure that it has completely thawed out before you switch it on.

8. Please feel the outgoing hot water temperature with your hands to make sure it is suitable for showering. As a result, you will avoid getting scalded.

9. Before connecting the pipes to the water heater hoses, it is extremely important to **FLUSH** the pipes to wash away all plumbing paste or residue in them.

10. The heating chamber is covered by composite nano insulation material; it is natural if there might be a bit of smell or green blue smoke when the unit is used for the first time.

11. If there is damage to the wire, you must contact a qualified electrician to replace it with specific wire from our authorized dealers.

12. **CAUTION: FOR HOUSEHOLD AND INDOOR USE ONLY.**

13. **CAUTION: Risk of electric shock, CONNECT ONLY TO A CIRCUIT THAT IS**



PRODUCT FEATURES

The tankless electric water heaters incorporate patented technology with multi-safety devices. Besides, the unit has the following features:

1. Tankless; instantaneous heating for on demand hot water; no pre-heating; no stand-by heating loss; energy-saving.

2. Micro-computer control; adopting patent heating technology. Water is completely separated from electricity by multi-layers of composite nano insulation material.

3. Over temperature protection: when the outgoing water temperature reaches over 140°F/60°C, the electricity will be cut off to avoid getting scalded and the screen will display E1. The appliance will start working automatically when the temperature drops to the set temperature.

4. Malfunction of sensor - when there is malfunction of the temperature sensor, the heater stops working and displays E3.

5. Conversion between degree Fahrenheit and degree Celsius.



ELECTRICAL DIAGRAM

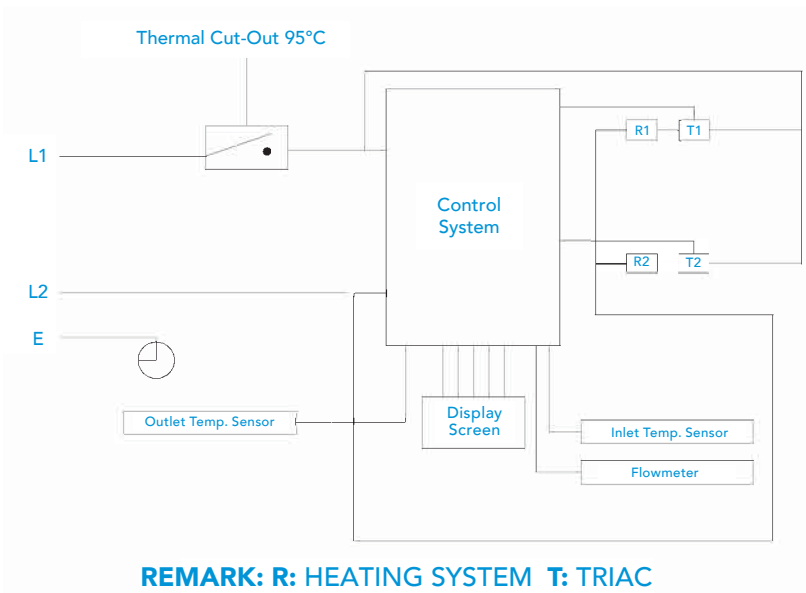

TECHNICAL SPECIFICATIONS AND INSTALLATION REQUIREMENTS

PRODUCT CODE	ECO150
Voltage	220V - 240V
Power	11kW
Min. Required Circuit Breaker Size	60A
Max. Amperage	45.8A
Recommended Wire Size	6 AWG
Min. Water Flow to Activate the Unit	0.53 GPM / 2L/min
Safe Operating Pressure	5 PSI - 85 PSI
Water Connections	½" NPT
Installation	Mounted Vertically
Temperature Setting	Digital Panel
Dimensions	8.7" X 14.2" X 3.5"
Weight	7.5 lbs

ECO110 GPM	Temp. Increase per GPM	
	1.0	75°F
	1.5	50°F
	2.0	38°F
	2.5	31°F
	3.0	28°F

Voltage	Max. Amperage	Power
208V	53A	11.0kW
220V	56A	12.3kW
240V	61A	14.6kW

*Gallons per minute indicated on the Temperature Increase table are calculated assuming an outlet temperature of 105°F. Variable factors such as alternate incoming water temperature or incorrect installation may yield different results.



240V



11 kW
Power



60 Amp
Breaker



Works with
Low Pressure



German
Technology



Overtemp
Protection



Multiple Points
Of Use



Digital Panel



50ft Max Distance
To Point of Use



Non-Corrosive



Micro-Chip
Computer



No Preheat



PRODUCT INNER STRUCTURE

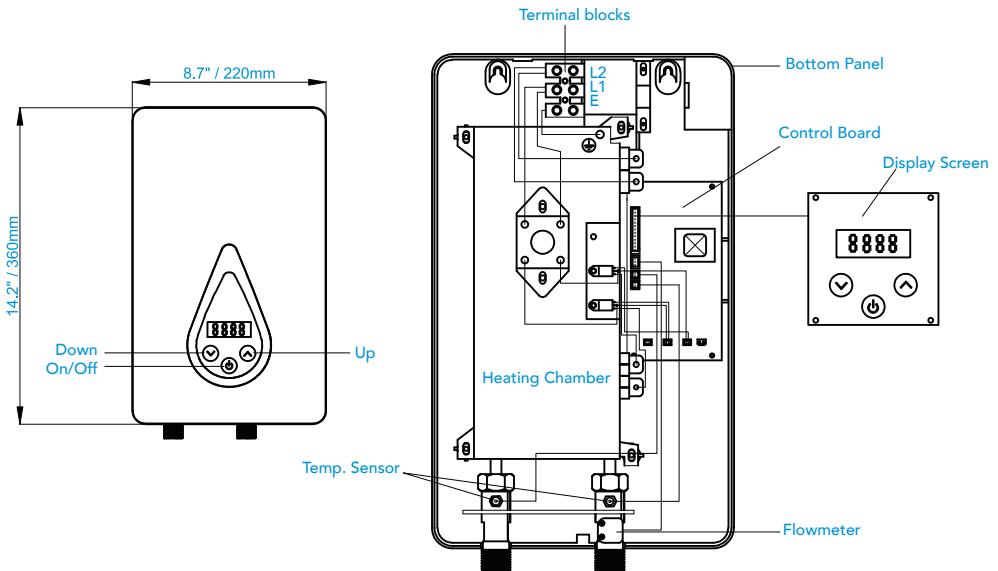

INSTALLATION GUIDELINE

The installation must be in compliance with the National Electrical Code, your local electrical and plumbing codes.

1. Make sure the appliance is intact, and the fittings are complete.
2. Please make sure the main power supply, water pressure, grounding condition, ammeter and wire reach the standard of installation requirement.
3. The appliance must be connected to properly grounded dedicated branch circuits of proper voltage rating. Ground must be brought to the "ground" at the circuit breaker panel.
4. This appliance **MUST** be permanently connected to the fixed circuit breaker. If you do not use the heater, please switch off the circuit breaker.
5. **DO NOT** install this appliance near tinder or a strong magnetic field place. The unit must only be assembled in a **VERTICAL** position near by the water fittings. Please try the unit after getting the water flow.



INSTALLATION DIAGRAM

FIXED INSTALLATION ON THE WALL

Locate an appropriate place on a section of the wall as mentioned above.

Fig. 01: Front and back of the appliance.

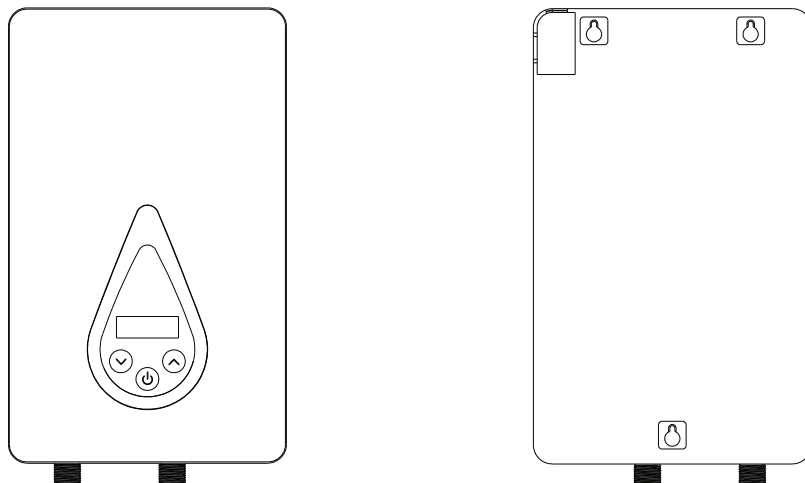

Fig. 02: Remove screws which are fixed at the front and back covers of the appliance.

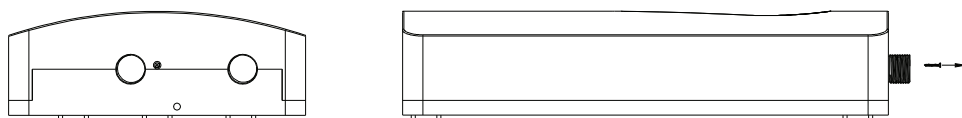

Fig. 03: Open the front cover, connect the cable to the terminal blocks, and please notice the guidance logo below the terminal blocks.

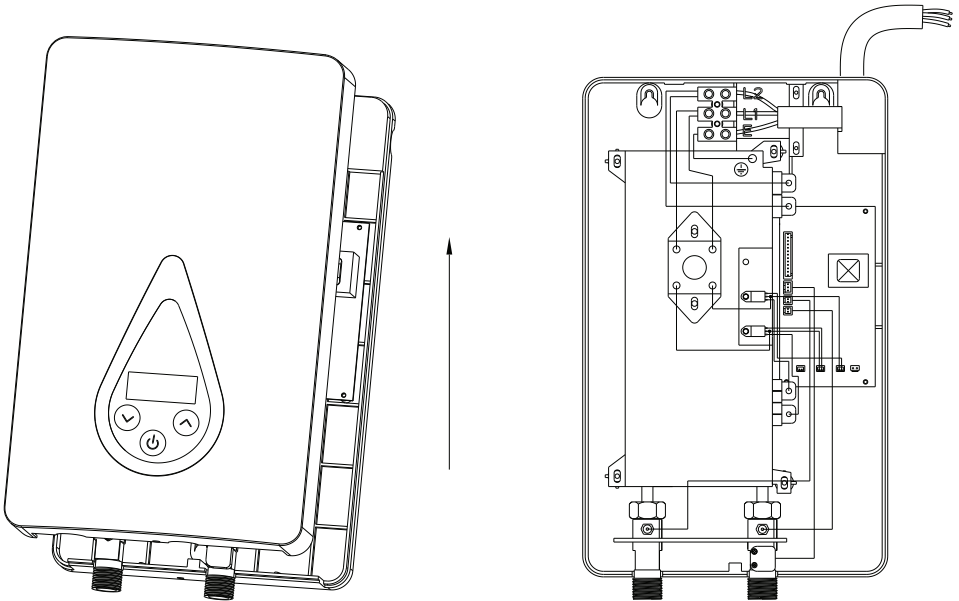

Fig. 04: Connect PCB row line of the front cover to PCB of the back cover, and then fix the front and back cover with locking screws.

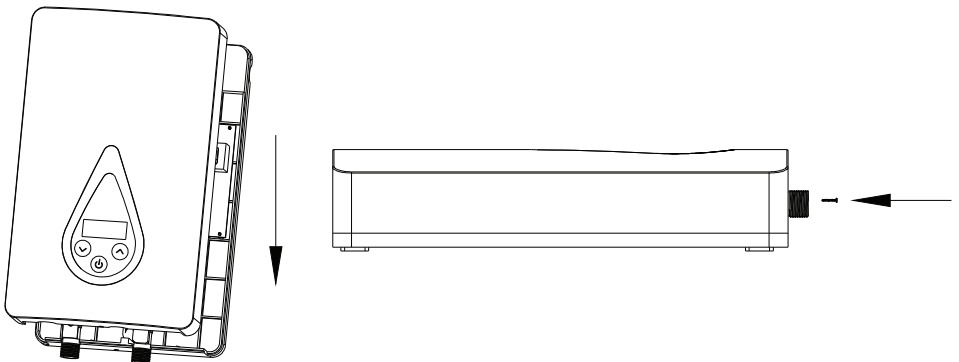

Fig. 05: Mark three mounting holes on the wall according to the following picture, then drill three holes of 6.00mm diameter. Put expansion bolts in the holes, and then screw the self tapping screws into the expansion bolts.

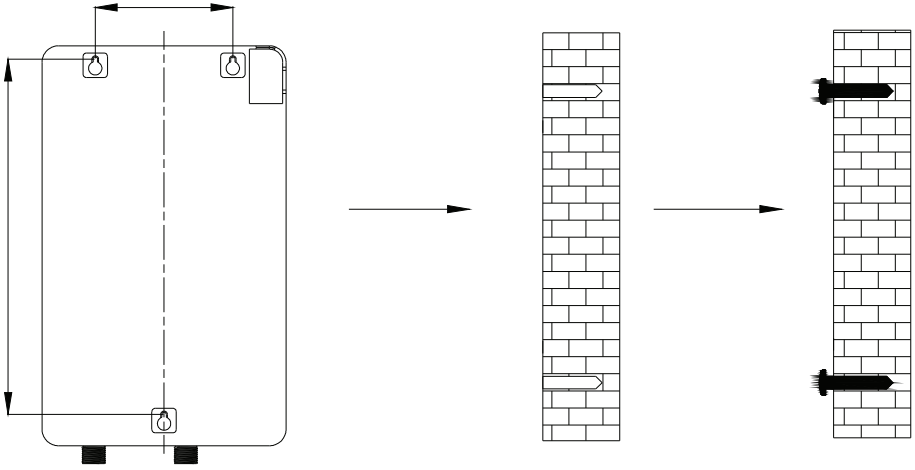

Fig. 06: Fix the appliance on the mounting screws.

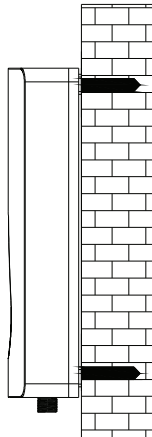
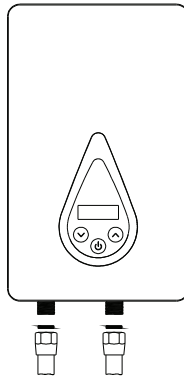

Fig. 07: Connect the water pipe to the water inlet and water outlet connections, please remember to install the rubber seal ring.



Water connections









1. All water pipes must comply with national and applicable state and local water pipe codes.
2. The unit should be connected directly to the main water supply. Flush the pipe with water to remove any debris or loose particles.
3. It is required to use 1/2" NPT water connections to fit the models on EC0110.
4. Please remember to install rubber seal rings at the connections. When all water connections are completed, check for leaks and take the necessary actions before proceeding.

Electrical connections

1. All electrical work must comply with national and applicable state and local electrical codes.
2. The unit must be connected to a properly grounded dedicated branch circuit of proper voltage rating.
3. EC0110 can be connected to a single circuit, using a supply cable protected by a double pole breaker.
4. While connecting the cable to the terminal blocks, please make sure the metal wiring

5. Before beginning any work on the electric installation, be sure that the main breaker panel switch is OFF to avoid any danger of electric shock. All mounting and plumbing must be completed before proceeding with electrical hook-up.

OPERATING INSTRUCTIONS

1. Turn on the circuit breaker to bring electrical power to the unit.
2. Open the water faucet for a few minutes until the water flow is continuous and all the air is purged from the water pipes. The unit must operate after the breakers are turned on
3. After the unit is supplied with power, a beep sound can be heard and LED lights appear  for 2 seconds; if there is no other display, the appliance keeps standby.
4. Press  to turn ON/OFF the appliance. When the unit is ON, LED lights show the actual outgoing water temperature. When the appliance stops working, after 5 seconds,  the screen switches on the screen saver. The display screen light will be off. If somebody touches the screen, the light will be on again.
5. Press  and  to adjust the outlet water temperature. Temperature setting range is 30-52°C/ 86-125°F.
 - If the unit has been paused, you may initially get a short burst of very hot water when you turn it on again. Please run the water through for a few seconds to let the temperature settle down. Please check the hot water with your hand before taking a shower. 
 - If the unit is not used in winter, drain out the water completely so that the heater does not freeze.
 - Please clean the inlet filter and the shower periodically in order to keep a proper water flow.
6. Press  to change the temperature display between Fahrenheit and Celsius degrees.
7. Press  to activate the automatic memory function to avoid repetitive operation. When you turn



TROUBLE-SHOOTING / DIAGNOSTIC CHART

PROBLEM	POSSIBLE CAUSES	CORRECTIVE ACTIONS
1. Inlet and outlet fittings leaking	A. Fittings not tight B. Rubber washer worn-out	A. Tighten fittings. B. Change rubber washer.
2. LED no signal	A. Power not connected. B. LCD damaged. C. LCD not connected to PCB.	A. Connect power to the unit. B. Change LCD. C. Connect LCD to the PCB Board
3. Functional keys not working	A. No water out from shower. B. Water pressure too low. C. Key or PCB damaged.	A. Open valve to get water. B. Open valve to get pressure. C. Change key or PCB.
4. Water too hot	A. Too high temperature set. B. Water flow too small.	A. Set a lower temperature. B. Open valve bigger.
5. Water too cold	A. Low temperature set. B. Water flow too much.	A. Set a higher temperature. B. Reduce water flow.
6. Outlet gets water smaller and smaller.	Inlet strainer or shower clogged.	Clean strainer and shower.
7. LED displays E1	A. Outlet temperature is over 60°C/140°F.	A. Reduce the temperature. B. Turn up the water flow.
8. LED displays E3		Please contact with the local dealer.

* 7 and 8 should only be performed by a qualified electrician. The person who initially installs the unit is the best one to contact for help.



NORMAL MAINTENANCE

Note: Do not attempt to repair this water heater yourself. Call a technician for assistance. The power supply always needs to be shut off when these operations are carried out.

Regular maintenance is not required. However, to ensure consistent water flow, it is recommended to follow these instructions:

1. Periodically remove scales and dirt that may build up at the aerator of the faucet or in the shower head.

2. There is a built-in filter screen at the inlet connection which should be cleaned from time to time. Please turn off the water flow before doing this.

Please feel free to contact us if you have any questions about our products, warranty service, or if you need assistance installing a unit.

We also strive for continuous improvement, so we welcome your comments, feedback and suggestions.



U.S.A

+1 (855) 627-3955

PUERTO RICO

(787) 727-0277

customerservice@marey.com

www.Marey.com

