



Item #1000051534  
Model #HH-1M-PC

# USE AND CARE GUIDE

---

## 3 LIGHT CHANDELIER

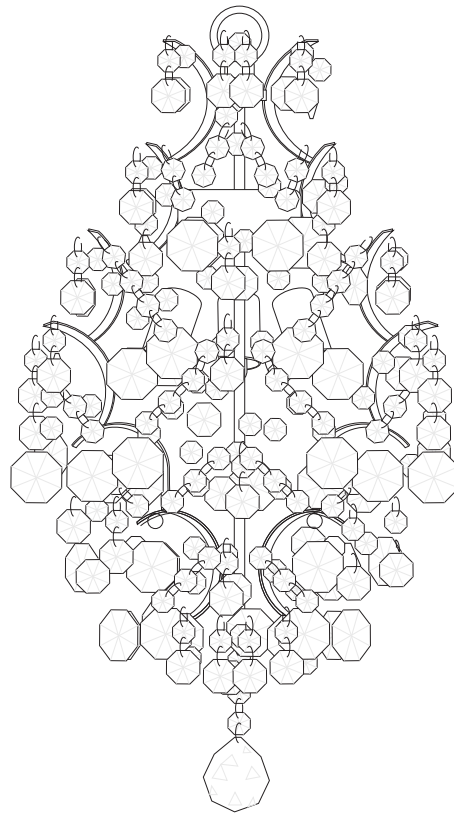

Questions, problems, missing parts? Before returning to the store,  
call Hampton Bay Customer Service  
8 a.m. - 6 p.m., EST, Monday-Friday

**1-855-HD-HAMPTON**

**HAMPTONBAY.COM**

---

### **THANK YOU**

*We appreciate the trust and confidence you have placed in Hampton Bay through the purchase of this light fixture. We strive to continually create quality products designed to enhance your home. Visit us online to see our full line of products available for your home improvement needs. Thank you for choosing Hampton Bay!*

# Table of Contents

Table of Contents .....	2	Package Contents .....	3
Safety Information.....	2	Installation .....	5
Warranty.....	2	Operation .....	7
Pre-Installation .....	2	Care and Cleaning .....	7
Planning Installation .....	2	Troubleshooting.....	7

# Safety Information

- Consult a qualified electrician if you have any electrical questions.

 **CAUTION:** Inspect the wire insulation for any cuts, abrasions, or exposed copper that may have resulted during shipping. If there is a defect in the wire, do not attempt installation. Please call our Customer Service Team at 1-855-HD-HAMPTON.

 **WARNING:** Before starting installation of this fixture or removal of a previous fixture, disconnect the power by turning off the circuit breaker or by removing the fuse at the fuse box.

# Warranty

The manufacturer warrants this lighting fixture to be free from defects in materials and workmanship for a period of five (5) years from date of purchase. This warranty applies only to the original consumer purchaser and only to products used in normal use and service. If this product is found to be defective, the manufacturer's only obligation, and your exclusive remedy, is the repair or replacement of the product at the manufacturer's discretion, provided that the product has not been damaged through misuse, abuse, accident, modifications, alterations, neglect, or mishandling. This warranty shall not apply to any product that is found to have been improperly installed, set-up, or used in any way not in accordance with the instructions supplied with the product. This warranty shall not apply to a failure of the product as a result of an accident, misuse, abuse, negligence, alteration, faulty installation, or any other failure not relating to faulty material or workmanship. This warranty shall not apply to the finish on any portion of the product, such as surface and/or weathering, as this is considered normal wear and tear. The manufacturer does not warrant and specially disclaims any warranty, whether express or implied, of fitness for a particular purpose, other than the warranty contained herein. The manufacturer specifically disclaims any liability and shall not be liable for any consequential or incidental loss or damage, including but not limited to any labor / expense costs involved in the replacement or repair of said product.

Contact the Customer Service Team at 1-855-HD-HAMPTON or visit [www.hamptonbay.com](http://www.hamptonbay.com).

# Pre-Installation

## PLANNING INSTALLATION

- Read all instructions before installation.
- To avoid damaging this product, assemble it on a soft, non-abrasive surface, such as carpet or cardboard.
- Keep your receipt and these instructions for proof of purchase.

# Pre-Installation (continued)

## TOOLS REQUIRED



Ladder



Safety glasses



Electrical tape



Phillips screwdriver



Flat blade screwdriver



Pliers



Wire strippers

## HARDWARE INCLUDED



**NOTE:** Hardware not shown to actual size.

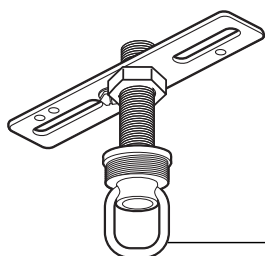

AA

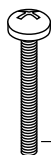

BB



CC

Part	Description	Quantity
AA	Mounting unit	1
BB	Mounting screw	2
CC	Wire nut	3

# Pre-Installation (continued)

## PACKAGE CONTENTS

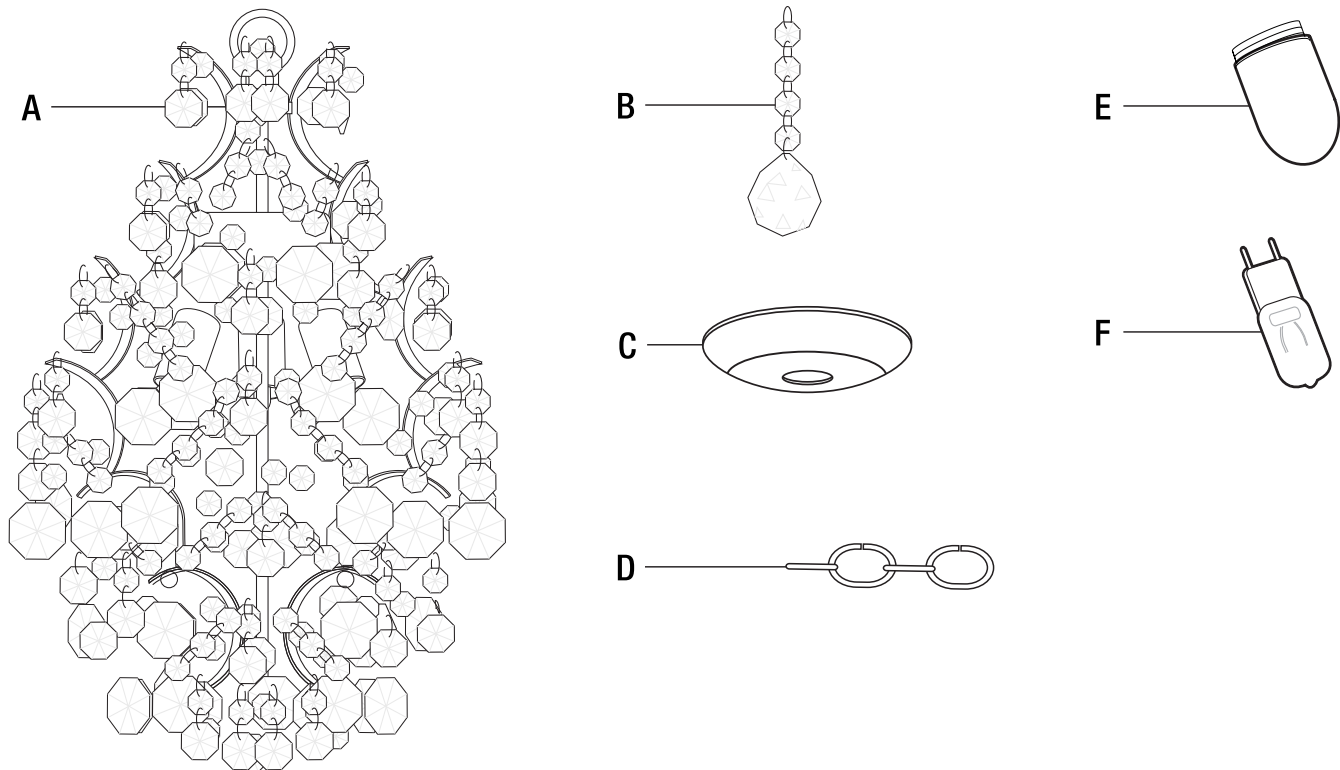

Part	Description	Quantity
A	Light fixture	1
B	Crystal	1
C	Canopy	1
D	Chain	1
E	Glass shades	3
F	G9 bulb	3

# Installation

## 1 Attaching the mounting bracket to the junction box

- Attach the mounting unit (AA) to an outlet box (not included) using mounting screws (BB). Then, remove the preassembled screw collar ring from the mounting unit (AA).

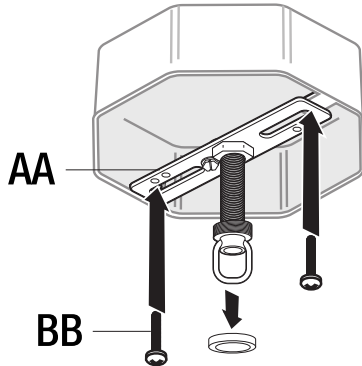

## 2 Placing the canopy

- Place the canopy (C) over the preassembled screw collar loop on the mounting unit (AA), and re-attach the screw collar ring until 1/2 of the screw collar loop threads are exposed.

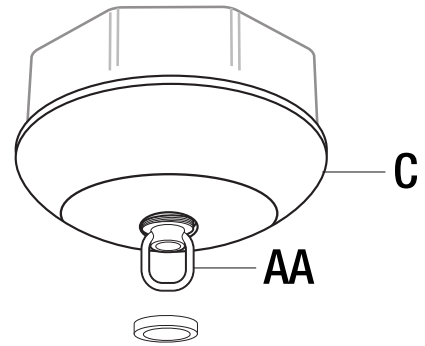

## 3 Attaching the chain to the ceiling

- Use a pair of pliers and a screwdriver (not included) to open the end link of the chain (D). Use a cloth on the pliers to protect the finish. Secure the chain (D) to the screw collar loop and the top loop of the fixture (A).

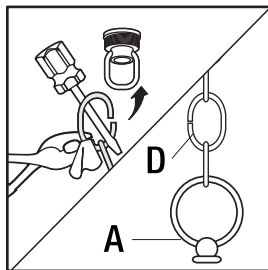

## 4 Weaving the wires

- Lower the screw collar ring and canopy (C) over the chain (D). Weave the electrical and ground wires from the light fixture (A) through the chain (D), screw collar ring, canopy (C), screw collar loop and into the center of the mounting unit (AA).

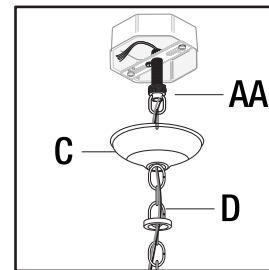

## 5 Making the electrical connections

- Connect the copper wire from the light fixture (A) to the mounting unit (AA) by securing it with the preinstalled ground screw.
- Connect the black to black (power), the white to white (neutral) and copper wire to ground wire with the wire nuts (CC) and secure with electrical tape (not included).



**NOTE:** If the wires from the fixture are the same color, attach the side with markings or letters to the black (positive) wire and the other to the white (neutral) wire.

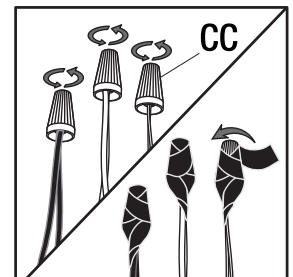
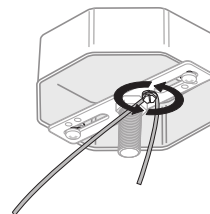

## Installation (continued)

### 6 Securing the canopy

- Re-secure the canopy (C) to the mounting unit (AA) with the screw collar ring.

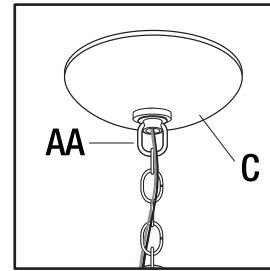

### 7 Installing the light bulbs

- Install three G9 bulbs (F) and screw the glass shades (E) onto the fixture (A).  
For more information on the proper light bulbs to use, see [www.homedepot.com/lightingfacts](http://www.homedepot.com/lightingfacts).

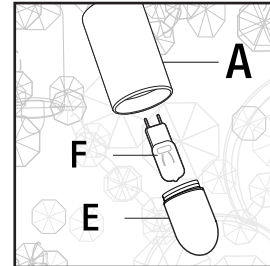

### 8 Installing the crystal

- Add the crystal (B) to the bottom loop.

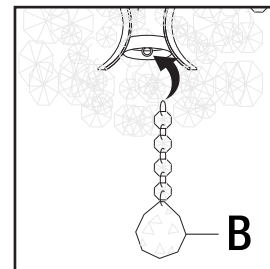

## Operation

### 1 Turning the light on

- Return power to the circuit breaker or fuse.
- Turn the light switch on to activate the fixture.

## Care and Cleaning

- Clean the lamp with a soft, dry cloth.
- Do not use any cleaners with chemicals, solvents, or harsh abrasives.

## Troubleshooting

Problem	Possible Cause	Solution
The bulb will not light.	The bulb is burned out.	Replace the light bulb.
	The power is off.	Ensure the power supply is On.
	There is a faulty wire connection.	Check the wiring.
	The circuit breaker is off.	Ensure the circuit breaker is in the On position.
The fuse blows or circuit breaker trips when the light is turned on.	There are crossed wires or the power wire is grounding out.	Check the wire connections. Contact a qualified electrician or call the Customer Service Team at 1-855-HD-HAMPTON.



Questions, problems, missing parts? Before returning to the store,  
call Hampton Bay Customer Service  
8 a.m. - 6 p.m., EST, Monday-Friday

**1-855-HD-HAMPTON**

**HAMPTONBAY.COM**

Retain this manual for future use.